

Worldwide offices

International

TADANO LTD.

International Division
4-12, Kamezawa 2-chome
Sumida-Ku, Tokyo 130-0014, Japan
Phone: +81-3-3621-7750
Fax: +81-3-3621-7785
E-mail: tdnihq@tadano.co.jp

TADANO AMERICA CORPORATION

4242 West Greens Road
Houston, TX 77066, USA
Phone: +1-281-869-0030
Fax: +1-281-869-0040
E-mail: sales@tadano-cranes.com

TADANO LTD. Middle East Representative Office

P.O.Box 18302, LOB15-323
Jebel Ali Free Zone, Dubai, UAE
Phone: +971-4-887-1353
Fax: +971-4-887-1703
E-mail: tadano@tadano.ae

TADANO LTD. Beijing Office

Jing Guang Centre, Room 2905, Hu Jia Lou
Chao Yang Qu
Beijing, China
Phone: +86-10-6597-3210
Fax: +86-10-6597-3220
E-mail: beijing@tadano.co.jp

Europe

TADANO FAUN GmbH

Faunberg 2
91207 Lauf a. d. Pegnitz
Germany
Phone: +49-9123-955-0
Fax: +49-9123-3085
E-mail: info@tadanofaun.de

TADANO SOUTH CHINA CO. LTD.

Room 1803, 18/F Seaview Commercial
Building 21-24 Connaught Road West
Hong Kong, China
Phone: +852-2544-9310
Fax: +852-2541-5828
E-mail: hiwa@tadanosc.com

TADANO Korea Co Ltd.

302, Koram Venture Town B/D
907-1 Daechi-Dong, Gangnam-Ku
Seoul 135-280, Korea
Phone: +82-2-714-1600
Fax: +82-2-3274-1304
E-mail: tadano@korea.com

TADANO Asia Pte Ltd.

11 Tuas View Crescent
Multico Building
Singapore 637643
Phone: +65-6863-6901
Fax: +65-6863-6902
E-mail: Tdn-crane@tadanoasia.com

TAIWAN TADANO LTD.

4F, No.50, Sung Chiang Road
Taipei
Taiwan
Phone: +886-2-2523-1388
Fax: +886-2-2523-3988
E-mail: tadano@ms18.hinet.net

TADANO FAUN HOLLAND B.V.

Antennestraat 6
3903 LZ Veenendaal
The Netherlands
Phone: +31-318-546-700
Fax: +31-318-542-282
E-mail: info@tadano-faun.nl

Detaillierte Informationen über unsere Internationalen Händler und Service Niederlassungen finden Sie im Internet.
For detailed information about our International Distributor and Service network, please refer to our homepages.

www.tadano.co.jp + www.tadanofaun.de + www.tadanoamerica.com

Herausgeber / Publisher:

TADANO FAUN GmbH
P.O.Box 10 02 64
91205 Lauf
Germany



ALL-TERRAIN ATF 40G-2

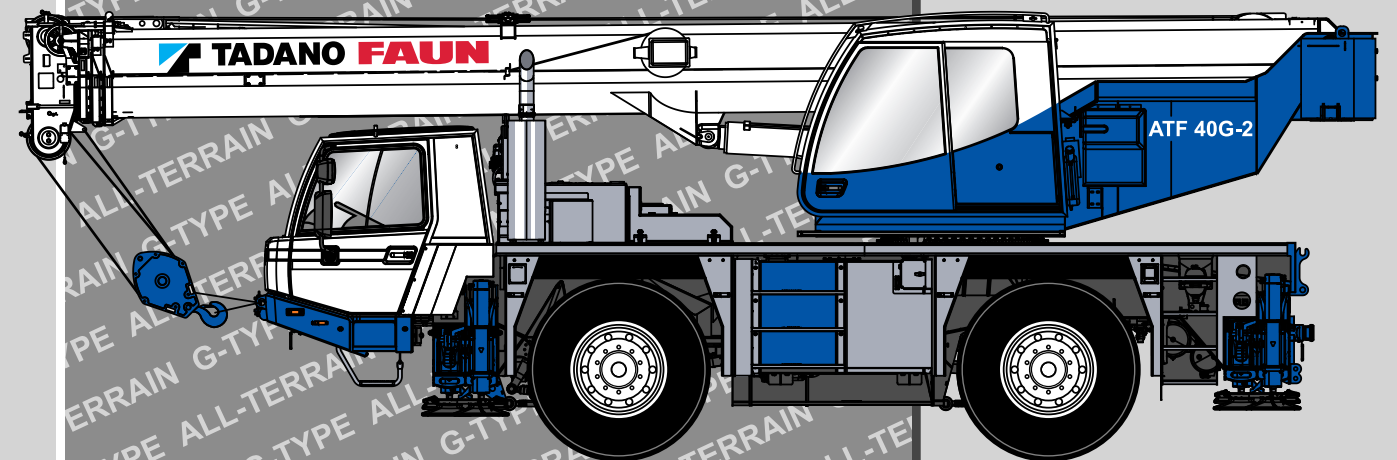

Maße (mm)
 Dimensions (mm)
 Dimensiones (mm)

 **14.00 R 25**
 (385/95 R 25)

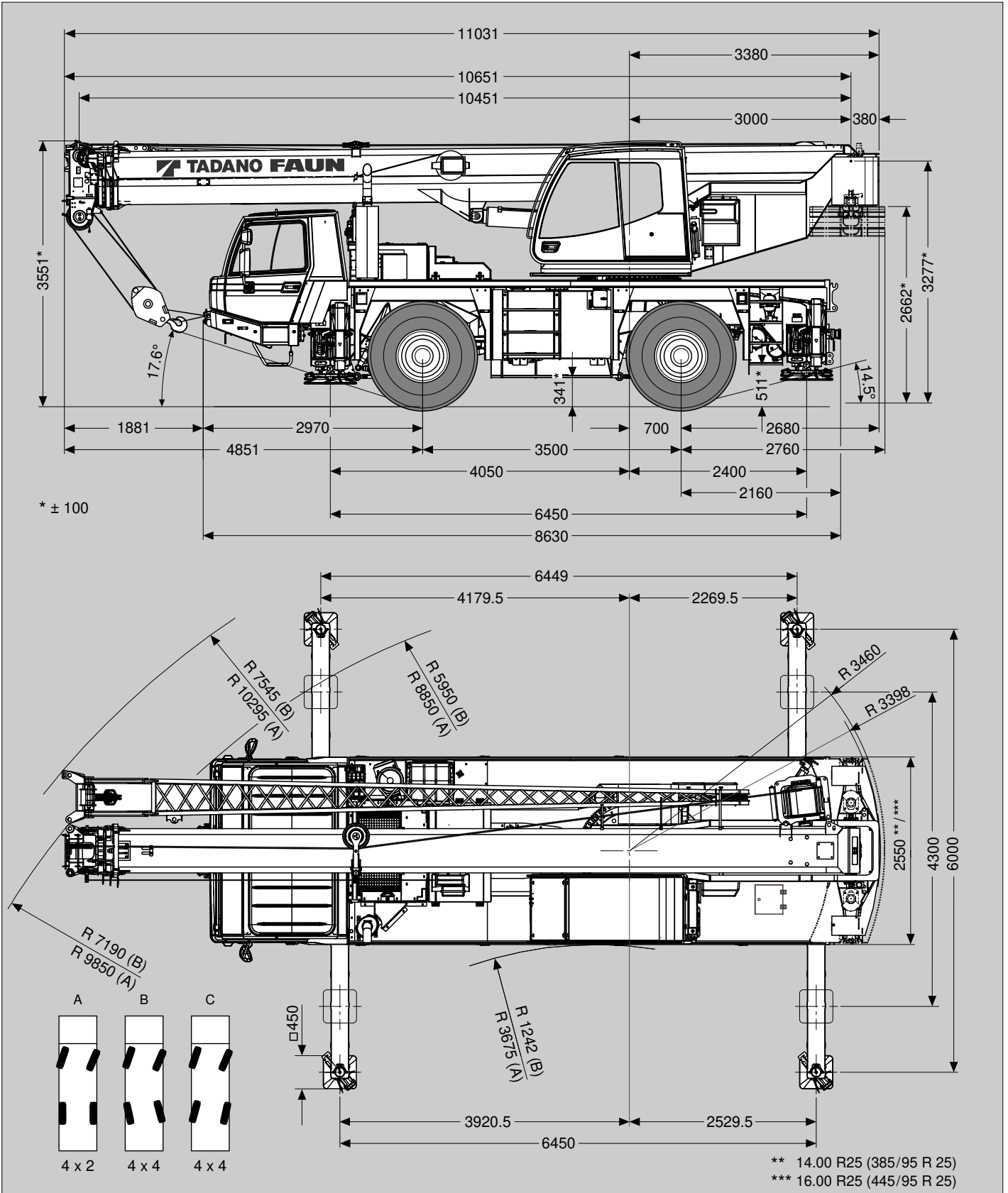

Gewichte / Geschwindigkeiten
Weights / Working speeds
Poids / Vitesses
Pesos / Velocidades de trabajo

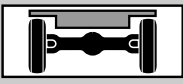
	Achse / Axle Essieu / Eje	1	2	Gesamtgewicht / Total weight Poids total / Peso total
	(t)	12	12	24*

* Incl. 1,4 t Gegengewicht, 9 m Auslegerverlängerung, 10 t Unterflasche, Antrieb 4 x 4, Bereifung 16.00 R 25 (445/95 R 25).





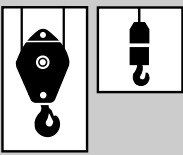

* Incl. 1.4 t counterweight, 9 m boom extension, 10 t hook block, drive 4 x 4, tyres 16.00 R 25 (445/95 R 25).



* Incl. de 1,4 t contrepoids, 9 m fléchette, 10 t moufle, entraînement 4 x 4, pneus 16.00 R 25 (445/95 R 25).

* Incl. contrapeso de 1,4 t, 9 m plumín, 10 t gancho, tracción 4 x 4, neumáticos 16.00 R 25 (445/95 R 25).

	Traglast / Lifting capacity / Force de levage / Capacidad de elevación	Rollen / Sheaves Pulies / Poleas	Stränge / Parts of line Brins / Ramales de cable	Gewicht / Weight Poid / Peso
	32 t	5	11	280 kg
	20 t	3	7	200 kg
	10 t	1	3	150 kg
	4 t	-	1	75 kg

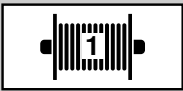

	1	2	3	4	5	6	R	
14.00 (385/95) km/h	0-5	0-7	0-11	0-17	0-27	0-41	0-5	74%
 	10	15	24	36	56	85	10	40%
16.00 (445/95) km/h	0-5	0-8	0-12	0-19	0-29	0-44	0-5	65%
 	10	16	26	39	61	85	11	36%

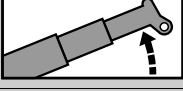
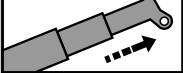
V+ 	Stufenlos Infinitely variable Progressivement variable Infinitamente variable	Seil Rope Câble Cable	Max. Seilzug Max. single line pull Effort maxi au brin simple Trio máximo por ramal
	0 - 135 m/min für einfachen Strang single line au brin simple ramal simple	14 mm / 150 m	33 kN
	0 - 2 min ⁻¹		
	-0.5° - +79°	ca. 36 s approx. 36 s env. 36 s aproximadamente 36 s	
	10.45 m - 35.20 m	ca. 80 s approx. 80 s env. 80 s aproximadamente 80 s	

Tragfähigkeiten
Lifting capacities
Capacités de levage
Capacidades de elevación

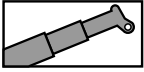

6.5t

DIN / ISO / EN

 m	10.5 m*	10.5 m	15.4 m	20.4 m	25.3 m	30.3 m	32.7 m	35.2 m
2.5	40.0**							
3.0	36.6**	32.1**	20.0	20.0	15.1			
3.5	33.9**	29.0	20.0	20.0	15.1			
4.0	30.6	26.4	20.0	20.0	15.1			
4.5	27.0	24.2	20.0	20.0	15.1	10.3		
5.0	24.1	22.2	20.0	20.0	14.8	10.3		
6.0	19.6	18.6	18.8	18.8	13.7	10.3	8.9	
7.0	15.0	15.0	15.3	15.4	12.7	10.3	8.9	
8.0			12.3	12.4	11.7	9.6	8.8	7.6
9.0			10.2	10.3	10.4	9.0	8.2	7.6
10.0			8.6	8.7	8.8	8.4	7.7	7.1
11.0			7.4	7.5	7.6	7.6	7.2	6.7
12.0			6.5	6.5	6.6	6.7	6.7	6.3
14.0				5.1	5.1	5.2	5.2	5.2
16.0				4.1	4.1	4.2	4.2	4.2
18.0					3.4	3.4	3.4	3.4
20.0					2.8	2.8	2.8	2.8
22.0					2.3	2.3	2.4	2.4
24.0						2.0	2.0	2.0
26.0						1.7	1.7	1.7
28.0							1.4	1.4
30.0								1.2
32.0								1.0

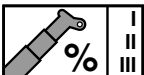

I
II
III

0	0	20	40	60	80	90	100
0	0	20	40	60	80	90	100
0	0	20	40	60	80	90	100

* Nach hinten / * Over rear / * A l'arrière / * Sobre la parte trasera

** Mit Zusatzhubausrüstungen / ** With additional lifting equipments / ** Avec équipements supplémentaires / ** Con equipos adicionales

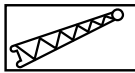
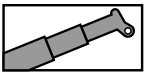

6.5t

DIN / ISO / EN

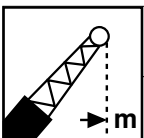
 m	10.5 m + 9.0 m			30.3 m + 9.0 m			35.2 m + 9.0 m		
	0°	20°	40°	0°	20°	40°	0°	20°	40°
3.0	6.5								
3.5	6.5								
4.0	6.5	6.5							
4.5	6.5	6.5							
5.0	6.5	6.4							
6.0	6.5	6.0		5.1					
7.0	6.5	5.6	4.7	5.1					
8.0	6.4	5.4	4.5	5.1			4.0		
9.0	6.0	5.1	4.4	5.1	4.6		4.0		
10.0	5.6	4.9	4.2	5.1	4.4		4.0		
11.0	5.3	4.6	4.1	4.9	4.2		4.0	3.7	
12.0	5.1	4.4	4.0	4.7	4.1	3.8	4.0	3.5	
14.0	4.6	4.1	3.9	4.3	3.8	3.5	3.7	3.3	3.1
16.0	4.2	4.0		4.0	3.6	3.3	3.4	3.1	2.9
18.0				3.6	3.4	3.2	3.2	2.9	2.8
20.0				3.0	3.2	3.0	2.9	2.8	2.6
22.0				2.5	2.7	2.8	2.5	2.6	2.5
24.0				2.1	2.3	2.4	2.1	2.3	2.4
26.0				1.8	1.9	2.0	1.8	1.9	2.0
28.0				1.5	1.6	1.7	1.5	1.6	1.7
30.0				1.3	1.4	1.4	1.2	1.4	1.4
32.0				1.1	1.1		1.0	1.1	1.2
34.0				0.9	0.9		0.9	0.9	1.0
36.0				0.8			0.7	0.8	
38.0							0.5	0.6	

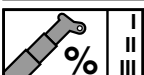

I
II
III

0	80	100
0	80	100
0	80	100

Hubhöhen
Lifting heights
Hauteurs de levage
Alturas de elevación

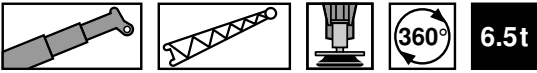

DIN / ISO / EN

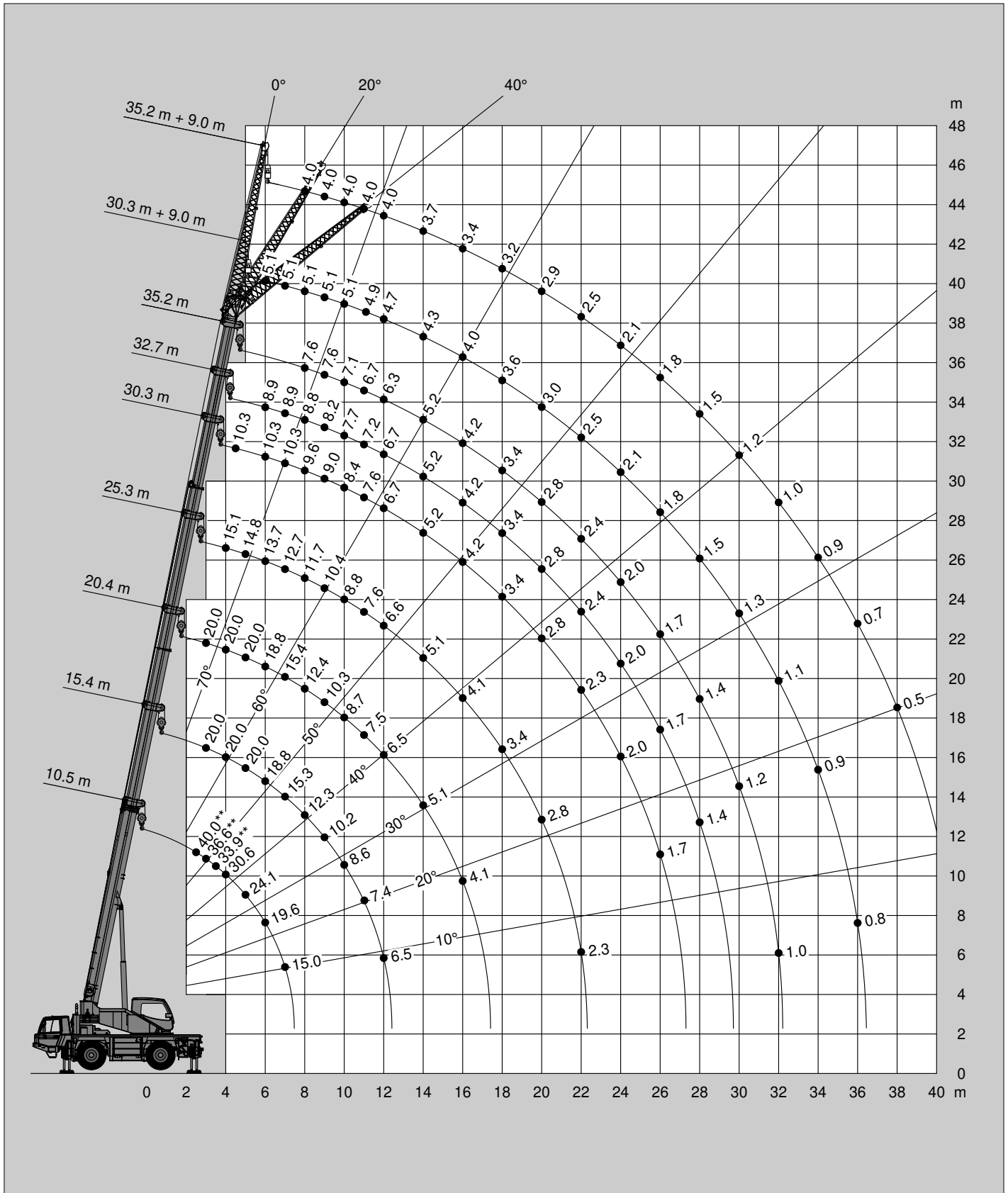

** Mit Zusatzhubausrüstungen / ** With additional lifting equipments / ** Avec équipements supplémentaires / ** Con equipos adicionales